

Model No.: GP450DHT

Type	: High Temperature Rechargeable Nickel Metal Hydride Cylindrical Cell
Nominal Dimension (with Sleeve)	: $\Phi = 33.0\text{mm}$ H = 60.5mm
Applications	: Long term standby use. Recommended discharge current: 450mA to 2250mA
Nominal Voltage	: 1.2V
Capacity	: Rated: 4500mAh Typical: 4725mAh When discharged at 900mA to 1.0V at 20°C
Charging Condition	: Standard mode: 450mA for 16 hrs at 20°C Standby intermittent mode: 450mA for 16 hrs at 20°C then maintenance with 450mA for 1min/10mins.
Charging Retention	: 80% of rated capacity after cell storage at 20°C for 12 months When discharged at 900mA to 1.0V at 20°C
Service Life	: >500 cycles (IEC standard)
Continuous Overcharge	: Comply with IEC standard Permanent Charge Endurance Test
Weight	: 115.5g
Internal Resistance	: Average 18m Ω upon fully charged (Max. 25m Ω) at 1000Hz
Max. Charging Voltage	: 1.6V at 450mA charging
Ambient Temperature Range	: Charge: 0 to 50°C Discharging: -20 to 70°C Storage: -20 to 35°C Storage (1 week): -20 to 60°C

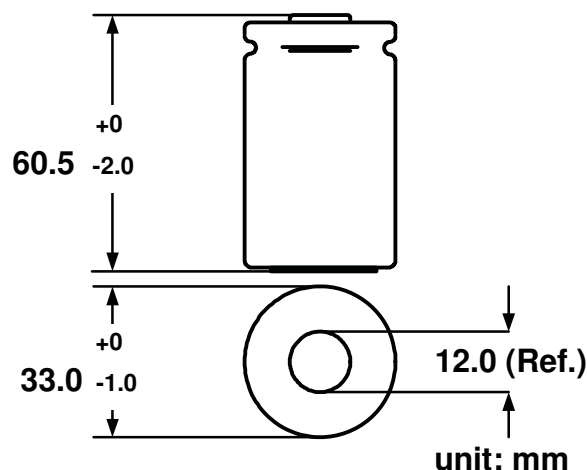

Low Rate Discharge

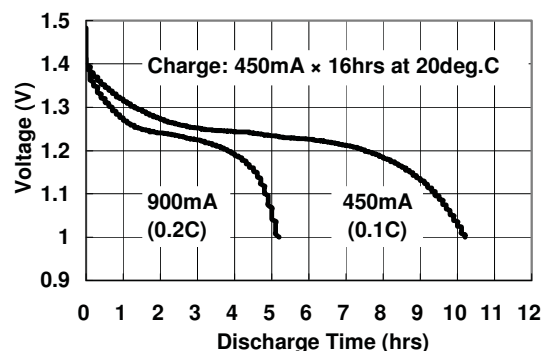

High Rate Discharge

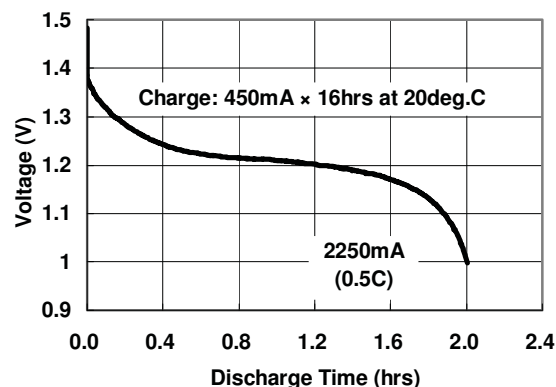

Charge & Discharge efficiency Vs. temp.

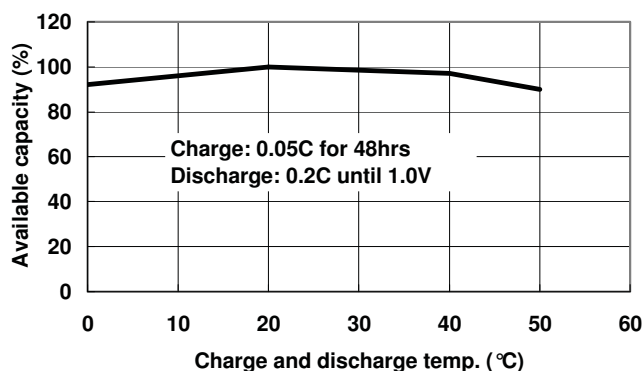

The information (subject to change without prior notice) contained in this document is for reference only and should not be used as a basis for product guarantee or warranty. For applications other than those described here, please consult your nearest GP Sales and Marketing Office or Distributors.