



Firma / Company : FRIWO

Gerätetyp / Type : OF150-48

Artikelnr. / Part-No. : 1893703

Zeichnungsnr. / Drawing-No. : 15.3541.500-00

Datum / Date : 2011-06-01

Sachbearbeiter Verkauf / Contact Sales : Bernsmann

Sachbearbeiter Mechanik / Contact Mech. Eng. : FEHVNL

Sachbearbeiter Elektronik / Contact Elec. Eng. : FESELU

Freigabe App. / Approved App. : FEPAZH

Freigabe / Approved : FELCCH

Wir bitten Sie, ein Exemplar mit Freigabevermerk an uns zurückzusenden. Sollten Sie dieser Spezifikation nicht unverzüglich widersprechen, gilt die Zustimmung und Fertigungsfreigabe auf Grundlage dieser Spezifikation als erteilt.

We may ask you to return one signed copy of this specification for our records as having your approval. Unless you do not enter your objection to the latest specification issue without delay, your acceptance and release for production on the basis of this specification is deemed to be given.

Kundenfreigabe / Customer Release

Datum / Date:

Unterschrift / Signature:

Index / Rev.	Datum / Date	Name	Einzelheit / Detail
Ⓐ	2012/01/11	Sean Liu	Add the output derating and the description of installation posit...
Ⓑ	2012/03/14	Sean Liu	Update the label and add the derating for installation positions.
Ⓒ	2012/09/06	Sean Liu	update UL mark.
Ⓓ	2013/07/04	Kuhn	Declaration of conformity updated, see point 8.

Geschäftssitz / Headquarter
 FRIWO Gerätebau GmbH
 Von-Liebig-Straße 11
 D-48346 Ostbevern
 Tel +49 2532/ 81-0
 Fax +49 2532/ 81-112
 www.friwo.de
 WEEE-Reg.-Nr. DE 70846847

Geschäftsführung / Management Board
 Felix Zimmermann
 Peter Vogt
 Lothar Schwemm
 St.-Nr. 346/5840/0923
 Finanzamt Warendorf
 USt.-Ident.-Nr. DE811114890
 Amtsgericht Münster
 HRB 9325

Bankverbindung / Bank Details
Sparkasse Münsterland-Ost
 BLZ 400 501 50 (EUR) Kto. 5 000 526
 IBAN DE42 4005 0150 0005 0005 26
 BLZ 400 501 50 (USD) Kto. 86 0000 23
 SWIFT WELADED1MST
Commerzbank AG, Frankfurt a. M.
 BLZ 500 400 00 Kto. 5 811 419
 IBAN DE05 5004 0000 0581 1419 00

1 Gehäuse / Housing:
 Gehäusertyp / housing-typ: open frame

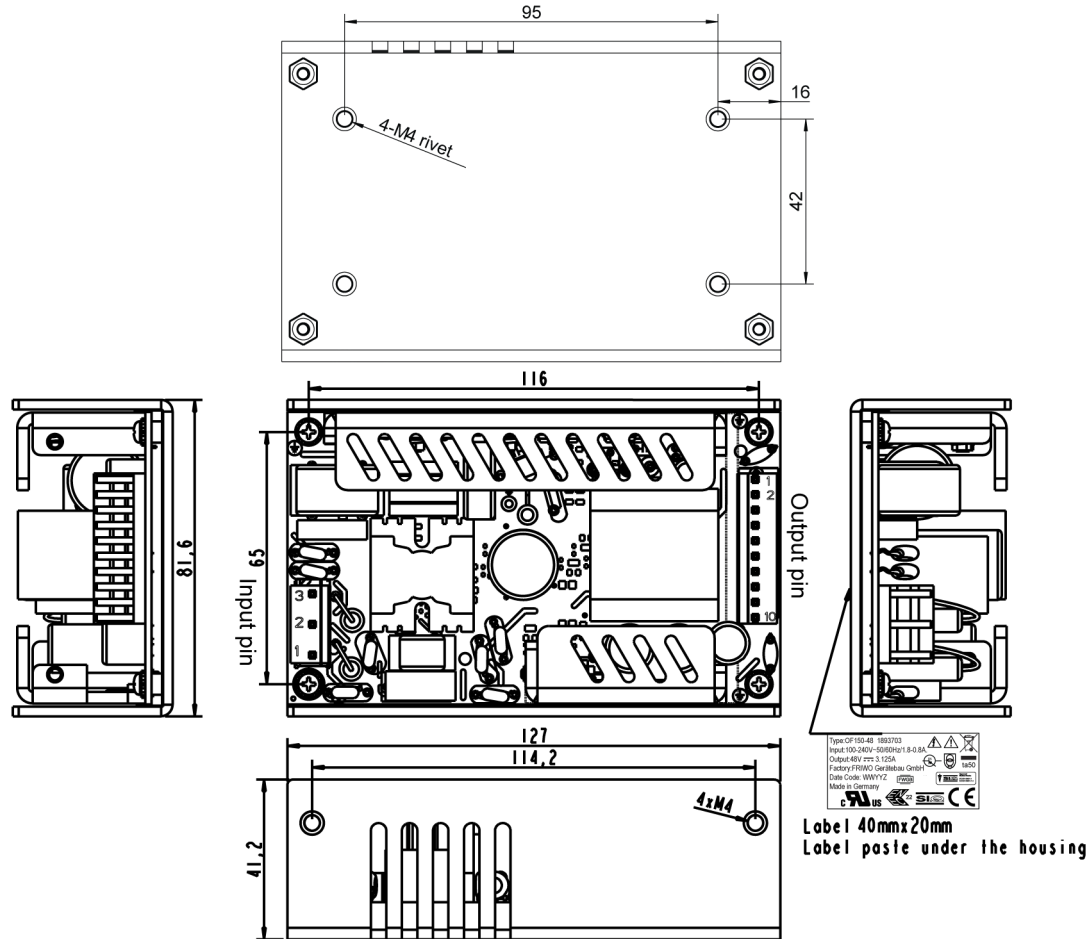

Item	Molex connector type or equivalent	Mating connector Molex type or equivalent
Input	0010634037	0009503051
Output	0026604100	0009503101

Output pin	1	2	3	4	5	6	7	8	9	10	Input pin	1	2	3
	+	+	+	+	-	-	-	-	-	-		PE	L	N

Falls das Netzteilmodul ohne das U-Profil betrieben werden soll, bitte beachten: Vor Inbetriebnahme des Netzteils müssen die vier mit dem Erdungssymbol gekennzeichneten Montagelöcher mit einer ausreichend niederohmigen ($\leq 0,1 \text{ Ohm}$) Verbindung versehen werden.

In case, the power supply shall be used without the U-bracket, please note: Before first use, the four mounting holes with "PE" symbol must be connected by a sufficiently low impedance ($\leq 0,1 \text{ Ohm}$) connection.

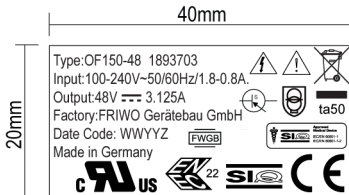

Printing: Black letter on white base
 Material: copperplate paper with bright/shining surface (UL, CSA approval)
 Coating: Acrylic adhesive backing
 To be manufactured by UL/CSA qualified vendor
 Storage temperature $-20 \text{ degC} \sim +70 \text{ degC}$
 The thickness of label is $0.12 \pm 0.02 \text{ mm}$
 "MMDDYYZ": MM=month DD=date YYYY=year Z=Factory code
 (Note: without mark = FRIWO Gerätebau GmbH)
 Where "XXXX" is running number starting from 0000 when DD is counted up

2 Verpackung / packaging:

Einzelverpackung / individual packaging:

ESD Poly bag:1815232(152x254mm).

Separator:1803273 11.3083.056-20.

Paste label 1834442(40x20mm) on ESD bag to close the ESD bag

OF150-48/1893703
48V \approx /3,125A

2.1 Sammelverpackung / bulk packaging: 28 er UMKARTON / Carton 28

Paste label 1830988(85x50mm) on master carton next to the standard label

OF150-48/1893703
48V \approx /3,125A

2.1.1 Aussenabmessungen / Outer dimensions: 433mm x 338mm x 196mm

2.2 Anzahl der Geräte pro Umkarton / amount of units per master carton: :18

2.3 Gewicht pro Stück / weight per unit: 450 g

2.4 Lagertemperatur / storage temperature: -20°C - +70°C / 10 to 95 rel. hum.

2.5 Verpackungsvorschriften / packaging specification:

Master Packing

Notes:

- 1) 18 pcs per carton
- 2) 6 cartons per layer
- 3) 5 layers on pallet
- 4) total 540 pcs per stack

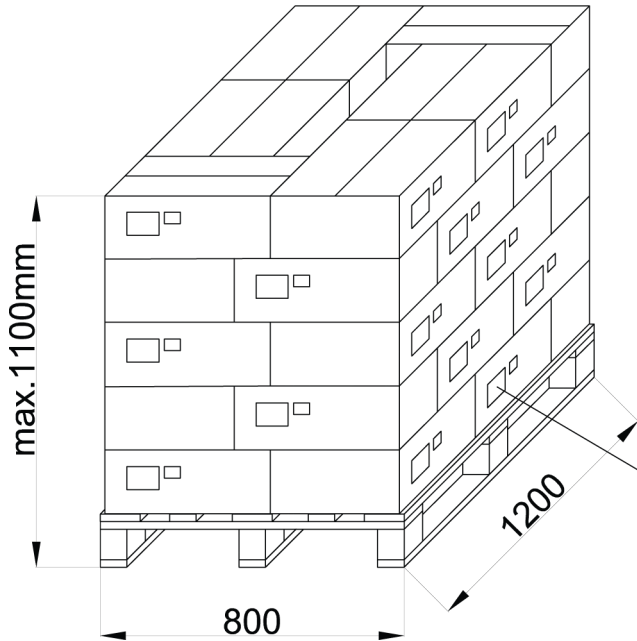

Pro Karton 1 Standard Aufkleber und 1 Aufkleber 1830988 auf der Längsseite des Kartons kleben/
 Paste per Carton 1 standard Label and 1 label 1830988 on the long side of the carton.

3 Elektrische Prüfbedingungen / electrical tests:

3.1 Alle nachstehend aufgeführten Werte werden bei +20°C Raumtemperatur und nach 15 Minuten Einschaltdauer gemessen.

All values listed below are measured at an ambient temperature of +20°C and after 15 minutes of operation.

3.2 Eingangsdaten / Input data:

3.2.1 Input fuse:3.15AH/250V

3.2.2 Nenneingangsspannung : 100-240V AC ±10%
 Nominal input voltage : 100-240V AC ±10%

3.2.3 Nenneingangsfrequenz : 47-63Hz
 Nominal input frequency : 47-63Hz

3.2.4 Leerlaufleistungsaufnahme bei U_E : 115V AC,230V AC : ≤ 0.5W
 Stand-by power consumption at U_{In} : 115V AC,230V AC : ≤ 0.5W

3.3 Ausgangsdaten / Output data

Messaufbau siehe / Measuring setup see <http://www.friwo.de>

3.3.1 Ausgangsspannung: U_A : 48V DC +5% / -5% U_{Br} : ≤ 480mVss
 Nominal output voltage: U_{out} : 48V DC +5% / -5% U_{Br} : ≤ 480mVpp

Ripple voltage test:100nF ceramic capacitor and 47uF aluminum electrolytic capacitor should be parallel at output terminal, and the oscilloscope with 20MHz bandwidth is required.

3.3.2 Nennausgangsstrom : I_A : 3125mA
 Nominal output current : I_{out} : 3125mA

3.3.3 Wirkungsgrad/Efficiency : ≥87%(Energy Star level "V")

3.3.4 Leistungsfaktor/Power Factor : ≥0.9

3.3.5 Überstromschutz/Over current protection

Steigt der Ausgangsstrom auf 4,5 A bis 5,5 A an, spricht der Überstromschutz an. Das Netzteil bleibt in diesem Betriebszustand bis die Überlastung beendet ist. Danach arbeitet das Netzteil normal weiter.

If the PSU output current rise to 4.5A~5.5A, the PSU will occur over-current protection and bouncing,until the over-current removed, PSU will work normally again.

3.3.6 Ausgangs-Kurzschluss-Schutz/Output short protection

Bei kurzgeschlossenem Ausgang spricht der Kurzschlussschutz an. Nach Entfernen des Kurzschlusses arbeitet das Netzteil normal weiter.

If the PSU output shorted, unit will enter bouncing, until the short circuit removed, PSU will work normally again.

3.4 Betriebstemperatur/Operating temperature

0 – 70°C (Vollast bis 50°C, danach lineare Abnahme der Leistung bis auf 50% bei 70°C)
 0-70°C(Full load to 50°C, derate linearly to 50% load at 70°C).

3.5 Ausgangskennlinie / Output characteristic:

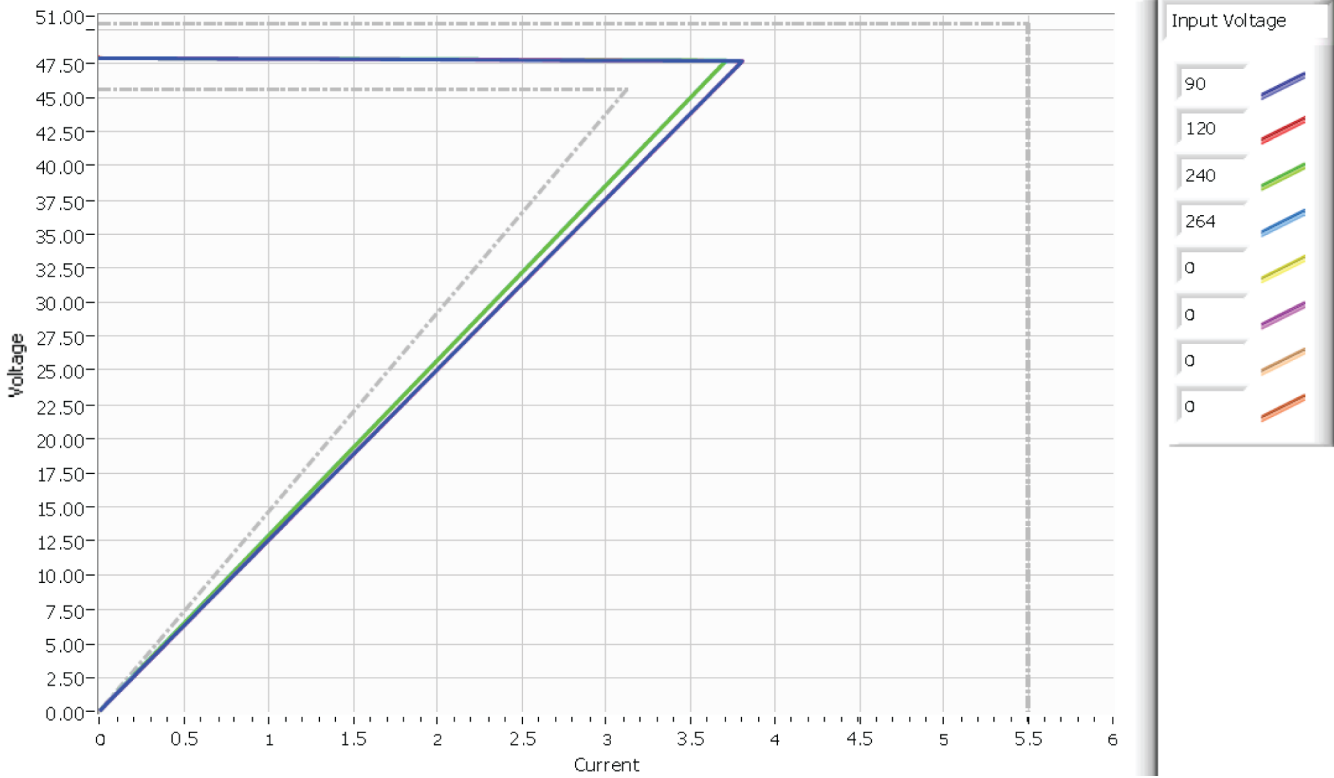

4 **Safety details:**

Sicherheitsstandards entsprechend EN60601,EN61558 und EN60950
Safety-standard acc. to : EN60601,EN61558 and EN60950

Schutzklasse: I
Protection class : I

Trennung (primär / sekundär): Galvanisch über Wandler
Separation (prim.-sec.) :Galvanic by transformer

Luft- und Kriechwege: \geq Kriechweg 8 mm, Luftweg 5 mm
Creepage distance and clearance : \geq Cr : 8mm,Cl : 5mm;

Erdableitstrom: \leq 500 μ A
Earth leakage current : I leak \leq 500 μ A

Gehäuseableitstrom: \leq 100 μ A
Enclosure leakage current : I leak \leq 100 μ A

Hochspannungstest: Primary to secondary \geq 4 KV AC;
Primary to earth \geq 1.5 KV AC; Secondary to earth \geq 500V AC
High-voltage test : Primary to secondary \geq 4 KV AC;
Primary to earth \geq 1.5 KV AC; Secondary to earth \geq 500V AC

Anwendungsbereich: Medizintechnik, Büro- und Telekommunikationstechnik
Range of application : Medical applications, Office and Telecom Applications

Umgebungstemperaturbereich: 0°C bis +50°C, bis zu +70°C mit 50% Leistungsabsenkung
Ambient temperature range : 0°C to +50°C ,derate 50% load at 70°C.

5 CE-Konformitätserklärung / Declaration of Conformity

Wir, der Hersteller, erklären hiermit, dass das Produkt: /
We, the manufacturer, hereby confirm, that the product:

Gerätetyp / Type: OF150-48
 Artikel-Nr. / Part-No.: 1893703
 Zeichnungs-Nr. / Drawing-No.: 15.3541.500-00

weitere Merkmale /
additional information:

mit der beiliegenden Beschreibung die Anforderungen der Niederspannungsrichtlinie 2006/95/EG, der EMV-Richtlinie 2004/108/EG und Öko-Design Richtlinie 2009/125/EG erfüllt.

Hiermit bestätigen und garantieren wir, dass unsere Produkte, unabhängig von der Produktionsstätte, RoHS-konform produziert werden und die Anforderungen der EU Richtlinie 2002/95/EC (Neufassung der Richtlinie 2011/65/EU) erfüllen.

with the enclosed description fulfils the requirements of the Low Voltage Directive 2006/95/EC, the regulations of the EMC Directive 2004/108/EC and the eco design Directive 2009/125/EC.

Hereby, we certify and guarantee that our products, regardless of the production location, RoHS compliant and fulfill the directive 2002/95/EC (revised version: directive 2011/65/EU).

Das Gerät entspricht der / *The unit corresponds to:*

a) Niederspannungsrichtlinie / <i>Low Voltage Directive</i>	b) EMV-Richtlinie / <i>EMC Directive</i>	c) Öko Design / <i>ECO Design</i>
<input type="checkbox"/> EN 60950-1 01/2011	<input type="checkbox"/> EN 55022 12/2011	<input type="checkbox"/> none
<input type="checkbox"/> EN 61558-2-16 07/2010	<input type="checkbox"/> EN 55024 09/2011	
<input type="checkbox"/> EN60601-1 Ed.3 07/2007	<input type="checkbox"/> EN 60601-1-2 12/2007	

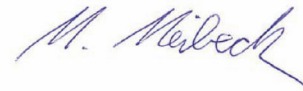

Quality Manager

i. V. Michael Meibeck

Ausstelldatum / *Date of issue*: 04.07.2013



Firmenstempel / Company stamp

Manager Product Design FPS i. V. Armin Wegener

6 Links & Miscellaneous

EMC-specification

6.1 Noise-suppressed:acc. to EN55024 ,55022/B and FCC part15B.

Suggest that the length of output wire is not in excess of 0.5m.

6.2 Harmonic current emissions ass.to IEC61000-3-2

6.3 Immunity to electrostatic discharge (ESD): acc. to IEC61000-4-2

Discharge characteristic	Test level	Assessment criteria Uin 120Vac	Assessment criteria Uin 230Vac
Air discharge	±8KV	B	B
Contact discharge	±6KV	B	B

6.4 Immunity to radiated electromagnetic field: acc. to IEC61000-4-3 Test characteristic: 80 - 2.5GHz; 80% AM (1 kHz)

Test level	Assessment criteria
10V/m	A

6.5 Immunity to fast electric transients (burst): acc. to IEC61000-4-4

Coupling	Test level	assessment criteria Uin 120Vac	assessment criteria Uin 230Vac
AC-input	±2KV	B	B

6.6 Surge capability: acc. to IEC61000-4-5

Surge voltage	assessment criteria Uin 120Vac	assessment criteria Uin 230Vac
±1KV(Line to Line)	B	B
±2KV(Line to earth)	B	B

6.7 Power frequency(50/60Hz) magnetic field.acc.to IEC61000-4-8.

Test level	Assessment criteria
3A/m	A

6.8 Immunity to voltage dips, short interruptions and voltage variations.

Test acc. to IEC61000-4-11

Test performed at $U_{in} = 120Vac/230VAC$

Voltage dips

Test level % U_N	Voltage dips and short interruptions	duration time of voltage dips (in halfsine)	Test result Uin 120Vac	Test result Uin 230Vac
0	100	0.5	B	B
		(5s)	B	B
40	60	5	B	B
70	30	25	B	B

6.9 Assessment criteria

a. Agreed operational behaviour within the specified limits.

b. Time limited functional diminishment of malfunction during the tests is permitted.The function is self-reactivated by the unit following completion of the tests.

c. Malfunction is permitted.The function can be reactivated either by reconnection to the mains or by operator intervention.

7 INSTALLATION INSTRUCTIONS

7.1 Rating

Type : OF150-48

Rated voltage : AC 100-240V

Nominal Current : Max 1.8A

Rated frequency : 50/60 Hz

Class : I

Protection against electric shock : By means of appropriate installation

Output voltages and currents DC48V/3,125A (SELV)

Max. ambient temperature for rated output power : 50°C

Max. operating relative humidity : 95%,no condensation.

Storage : -20 to +70°C

Units should be allowed to warm-up under non-condensing conditions before application of power.

Remark : the end-use product shall provide an adequate enclosure to prevent access to the power supply and have an adequate enclosure for protection against the spread of fire.

7.2 Classification

Protection against electric shock = Class I,mains grounded input (protective earth must be connected to mains supply network).

Protection against moisture:

Have not been evaluated for use in the presence of a flammable anaesthetic mixture with air,oxygen,or nitrous oxide.This evaluation is to be made on the end equipment by the OEM.

Do not connect as direct power source to patient circuits.





Not to be used as single power source within critical life support systems,without prior request to FRIWO Geratebau GmbH and receipt of confirmation in writing from FRIWO Geratebau GmbH.

Ask for Application Engineering Support from FRIWO Geratebau GmbH.

7.3 Temperatures

The maximum operating temperatures of certain safety components, as defined in the applicable safety standards, must not be exceeded after installation to preserve the intended safety.The output power,ambient air temperature and the availability,amount,direction and/or restriction of airflow influence the temperatures of these components.

8 Explanation of symbols

EXPLANATION OF SYMBOLS	
	Alternating Current
	Direct Current
	Attention, Consult Accompanying Documents
	Attention, Dangerous Voltages
	Earth (Ground)

- 8.1 Fusing**
Fuses for both Line and Neutral are provided in the power supply. Replace only with same type and rating of use.
- 8.2 Caution**
Read instruction manual before connecting to mains.
- 8.3 Warning! Risk of fire!**
A blown internal fuse is an indication of catastrophic failure of circuit component(s). Refer to fuse marking on the supply for rating.
- 8.4 Warning! Shock Hazard!**
Dangerous voltages are present on some components, printed wiring traces and heatsinks.

9 Installation method

9.1 Assembly on side

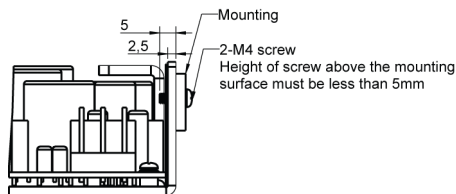
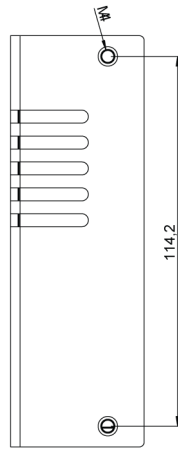

9.2 Assembly on front

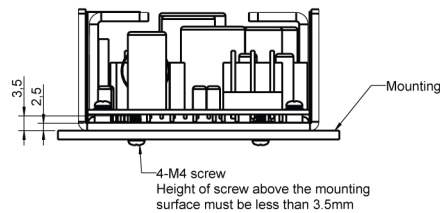
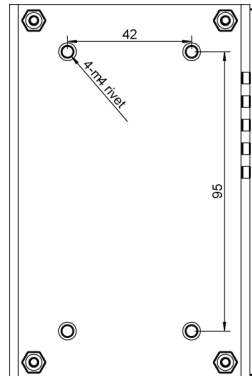

10 Installation positions versus output derating

Need to check all safety components' temperatures do not exceed the limits.

10.1 Ideal installation positions:

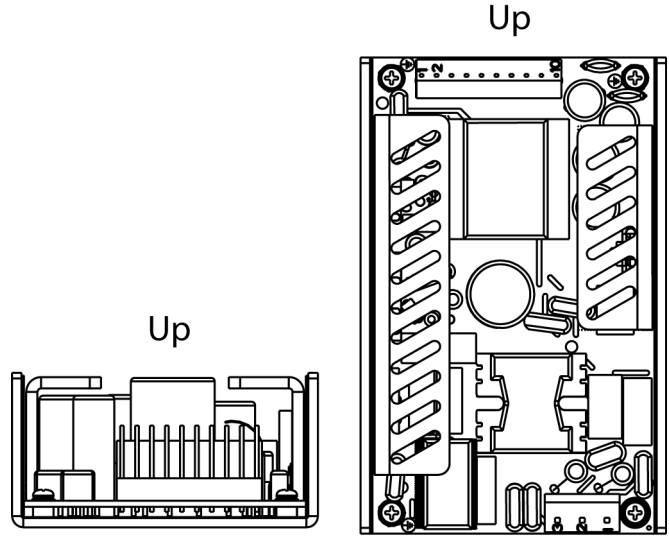

Output derating

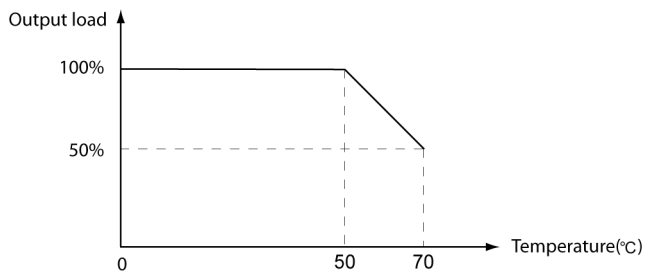
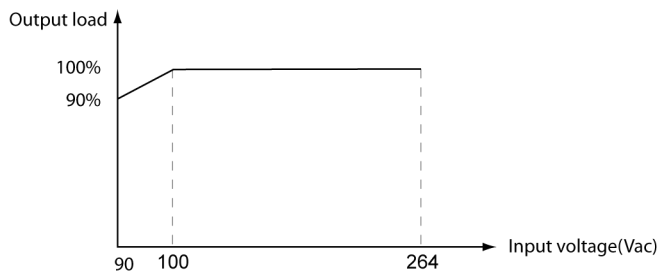

10.2 Acceptable installation positions(See output derating below):

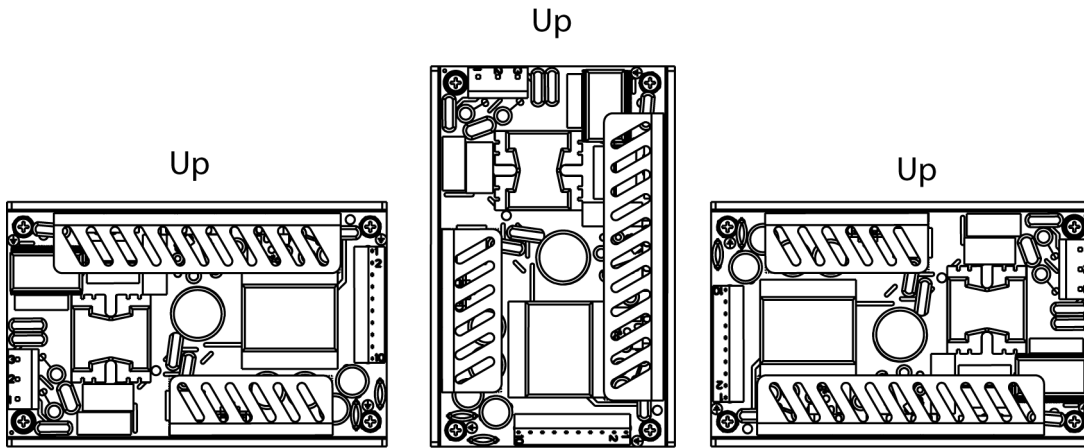

Output derating

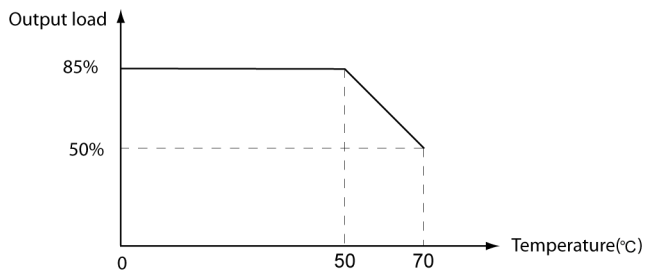
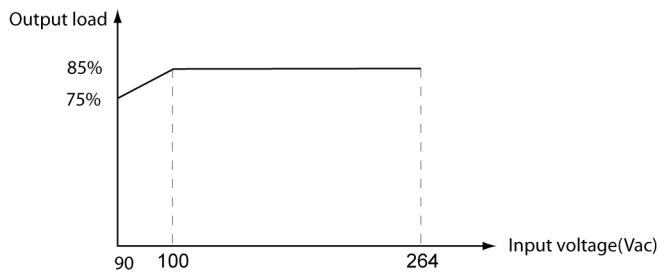

10.3 Unacceptable installation position:

UP

